



## Chimney fan RSHT

High temperature resistant **exodraft** fan type RSHT is a specially designed flue gas fan with horizontal discharge.

It is fitted to the termination point of the chimney and there creating a negative pressure in the exhaust duct or in the chimney. The stainless steel and cast aluminium housing ensure the RSHT very high corrosion resistance.

All the screws and bolts are made of stainless steel and so is the centrifugal impeller which has a very low vibration level.

The cooling wheel, patented by **exodraft**, allows the fan:

- to work reliably in continuous operation with temperatures up to **500 °C**
- to work in peak temperatures of up to **700 °C** in 3 minutes

### Technical data

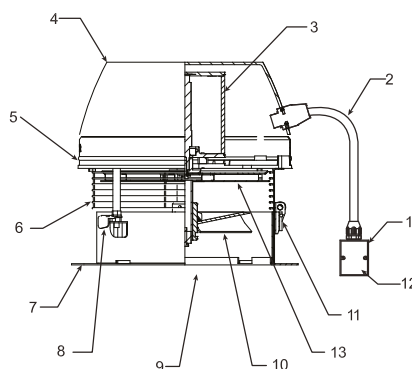
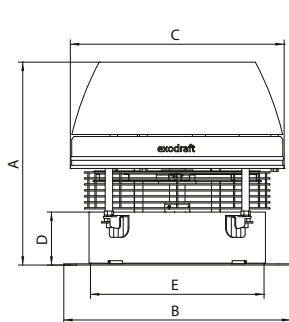

- 1 Capacitor and repair switch box
- 2 Conduit/cord
- 3 Motor
- 4 Motor housing
- 5 Motor plate
- 6 Bird screen
- 7 Base plate
- 8 Locking handle
- 9 Inlet
- 10 Axial vane
- 11 Hinge
- 12 Capacitor (inside box)
- 13 Cooling wheel

Type	Motor data				Weight kg	Dimensions (mm)				
	RPM	V	Amps	kW*		A	B	C ø	D	E ø
RSHT009-4-1	1400	1 x 230	0,4	0,09	12	298	296	275	75	220
RSHT012-4-1	1400	1 x 230	0,6	0,13	15	325	364	344	85	280
RSHT014-4-1	1400	1 x 230	1,2	0,29	19	372	422	395	100	330
RSHT016-4-1	1400	1 x 230	1,8	0,37	22	400	478	441	100	380

Type \ Lw(dB)	125 Hz	250 Hz	500 Hz	1000 Hz	2000 Hz	4000 Hz	8000 Hz	LP dB(A)
RSHT009-4-1	66	61	63	57	58	57	51	37
RSHT012-4-1	72	74	71	65	66	62	54	33
RSHT014-4-1	80	76	72	70	71	68	61	49
RSHT016-4-1	84	81	75	74	73	70	65	52

\* Power absorbed with an ambient temperature of 20 °C  
The rotational speed of the flue gas fan is steplessly variable on all single phase 230 V versions.  
Protection rating IP 54, Insulation class F

## Capacity diagrams

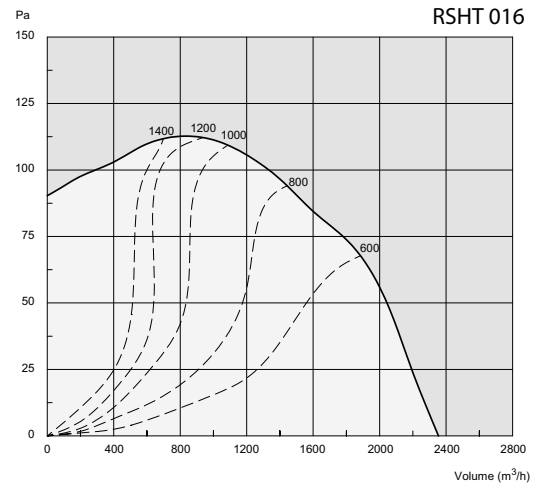
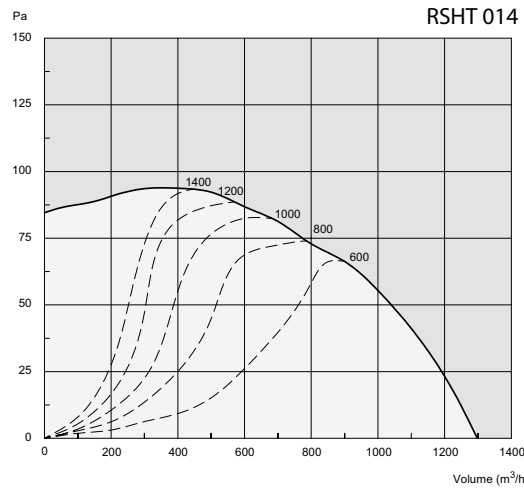
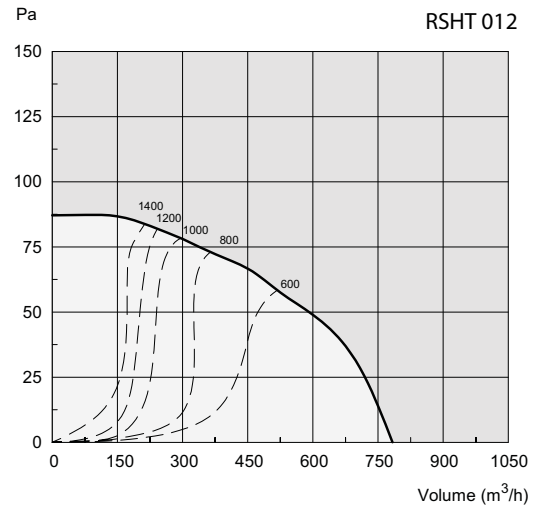
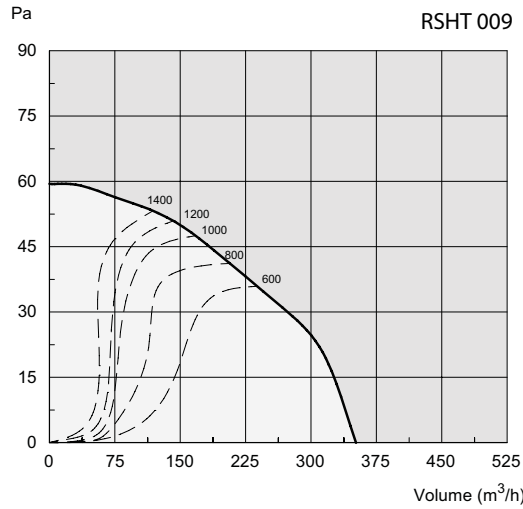

<p>--- Specific Fan Power (SFP) curve                  Capacity curve</p>	
<p><b>SFP</b>                  SFP = (joule/m<sup>3</sup>)                  P1 = consumption (watt)                  qv = flow (m<sup>3</sup>/h)</p>	$P1 = \frac{SFP \times qv}{3600}$
<p><b>Capacity curve</b>                  The capacity diagrams are measured with a flue gas temperature of 20 °C. The fan's capacity changes with the temperature of the flue gases. The correction of the capacity can be calculated using the following equation:</p>	
$P_{s_{20}} = P_{s_t} \times \frac{(273 + t)}{293}$	<p><math>P_s</math> = static pressure  <math>t</math> = temperature measured in °C</p>
<p>Example: (RSHT012)                  System demand: 600 m<sup>3</sup>/h and 32 Pa at 180 °C                  Fan selection: 600 m<sup>3</sup>/h and 50 Pa at 20 °C</p>	

## Sound data RSHT 009

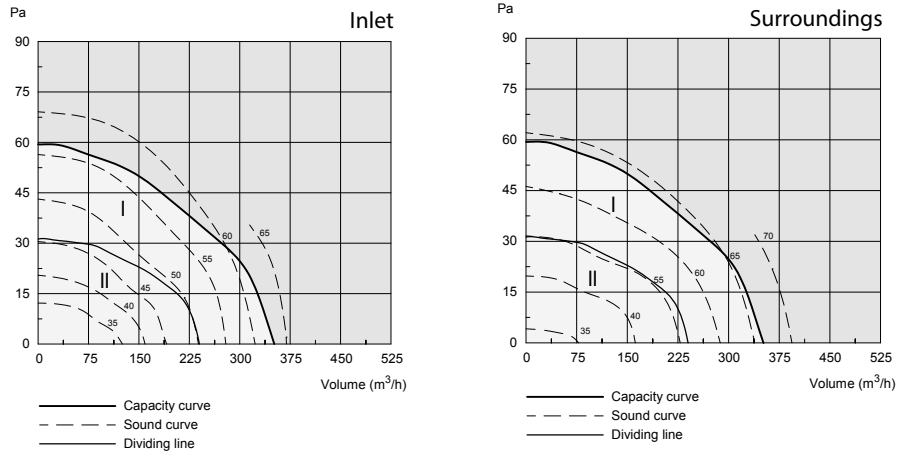

Correction factors for calculating sound output in the first octave band to extractor channel and surroundings. [dB]										
	Area	63Hz	125 Hz	250 Hz	500 Hz	1000 Hz	2000 Hz	4000 Hz	8000 Hz	
Inlet channel ( $K_{W1}$ )	I	16	13	3	-6	-12	-13	-18	-26	
	II	18	12	1	-5	-8	-13	-18	-23	
Surroundings ( $K_{W2}$ )	I	2	1	-4	-2	-8	-7	-8	-14	
	II	12	8	-1	-2	-7	-10	-10	-13	

Correction factors for calculating A-weighted sound pressure to surroundings [dB(A)]										
	Area	10m								
Pressure ( $K_{PA}$ )	I	-28								
	II	-28								

Example: Sound power output level for inlet channel [dB] = (Readings in Diagram A) + (Correction factor in Table 1)										
	Area	63Hz	125 Hz	250 Hz	500 Hz	1000 Hz	2000 Hz	4000 Hz	8000 Hz	
Sound power output to inlet channel in the first octave band ( $L_{W1}$ )	I	73	70	60	51	45	44	39	31	
	II	-	-	-	-	-	-	-	-	

Example: Sound power output level for surroundings [dB] = (Readings in Diagram B) + (Correction factor in Table 1)										
	Area	63Hz	125 Hz	250 Hz	500 Hz	1000 Hz	2000 Hz	4000 Hz	8000 Hz	
Sound power output to surroundings in the first octave band ( $L_{W2}$ )	I	65	64	59	61	55	56	55	49	
	II	-	-	-	-	-	-	-	-	

Example: Sound pressure to surroundings [dB(A)] = (Readings in Diagram B) + (Correction factor in Table 2)										
Every time that distance doubles another 6 dB is withdrawn. Example: 20m = 63 - 28 - 6=29										
	Area	10m	20m	40m	80m					
A-weighted sound pressure in ( ) meters distance ( $L_{PA3}$ )	I	35	29	23	17					
	II	-	-	-	-					

Example: For the values in Table 3 is read the factor ( $L_{WA1}$ ) in Diagram A at 2/3 of max. flow.  
 2/3 of 250 M<sup>3</sup>/h = 167 M<sup>3</sup>/h  
 Reading = 57

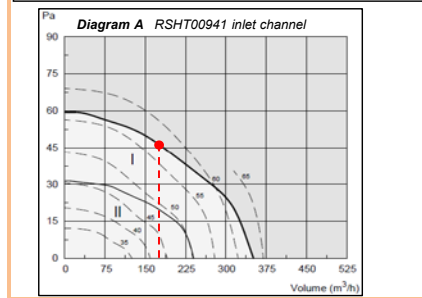

Example: For the values in Table 4 and Table 5 is read the factor ( $L_{WA3}$ ) in Diagram B at 2/3 of max. flow.  
 2/3 of 250 M<sup>3</sup>/h = 167 M<sup>3</sup>/h  
 Reading = 63

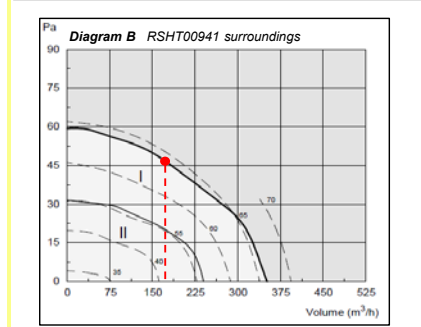

$K_{W1}$ : Correction factor for calculating sound output in the first octave band.  
 $K_{PA}$ : Correction factor for calculating A-weighted sound pressure.

$L_{W1}$ : Sound output level for inlet channel  
 $L_{W2}$ : Sound output level for surroundings  
 $L_{PA3}$ : Sound pressure level dB(A) at a distance of 10 metres from hemi-spherical sound dissipation in free field and with insulated connection ducts.

I: Upper operating area.  
 II: Lower operating area.  
 $L_{WA1}$  can be read from the curve diagram.  
 $L_{WA3}$  can be read from the curve diagram.

## Sound data RSHT 012

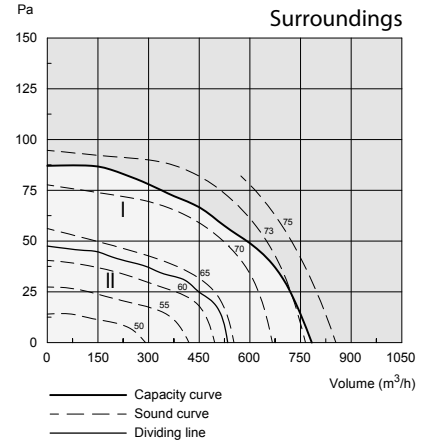
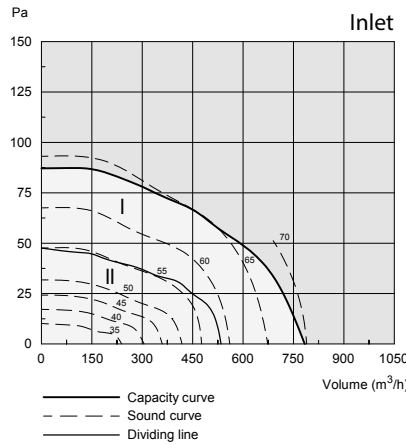

	Area	63Hz	125 Hz	250 Hz	500 Hz	1000 Hz	2000 Hz	4000 Hz	8000 Hz
Inlet channel ( $K_{W1}$ )	I	15	12	3	-7	-11	-14	-17	-23
	II	18	12	2	-5	-9	-13	-22	-29
Surroundings ( $K_{W2}$ )	I	0	-1	1	-2	-8	-7	-11	-19
	II	8	6	4	-5	-8	-9	-13	-18

	Area	10m						
Pressure ( $K_{pA}$ )	I	-28						
	II	-28						

	Area	63Hz	125 Hz	250 Hz	500 Hz	1000 Hz	2000 Hz	4000 Hz	8000 Hz
Sound power output to inlet channel in the first octave band ( $L_{W1}$ )	I	80	77	68	58	54	51	48	42
	II	-	-	-	-	-	-	-	-

	Area	63Hz	125 Hz	250 Hz	500 Hz	1000 Hz	2000 Hz	4000 Hz	8000 Hz
Sound power output to surroundings in the first octave band ( $L_{W2}$ )	I	71	70	72	69	63	64	60	52
	II	-	-	-	-	-	-	-	-

A-weighted sound pressure in ( ) meters distance ( $L_{pA3}$ )	Area	10m	20m	40m	80m			
	I	43	37	31	25			
	II	-	-	-	-			

**Example:** For the values in **Table 3** is read the factor ( $L_{WA1}$ ) in **Diagram A** at 2/3 of max. flow.  
2/3 of 825 M<sup>3</sup>/h = 550 M<sup>3</sup>/h  
Reading = 65

**Example:** For the values in **Table 4** and **Table 5** is read the factor ( $L_{WA3}$ ) in **Diagram B** at 2/3 of max. flow.  
2/3 of 825 M<sup>3</sup>/h = 550 M<sup>3</sup>/h  
Reading = 71

**exodraft a/s**  
C. F. Tietgens Boulevard 41  
5220 Odense SØ  
Denmark

www.exodraft.com

$K_{W1}$ : Correction factor for calculating sound output in the first octave band.  
 $K_{pA}$ : Correction factor for calculating A-weighted sound pressure.

$L_{W1}$ : Sound output level for inlet channel  
 $L_{W2}$ : Sound output level to surroundings  
 $L_{pA3}$ : Sound pressure level dB(A) at a distance of 10 metres from hemi-spherical sound dissipation in free field and with insulated connection ducts..

I: Upper operating area.  
II: Lower operating area.  
 $L_{WA1}$  can be read from the curve diagram.  
 $L_{WA3}$  can be read from the curve diagram.



## Sound data RSHT 014

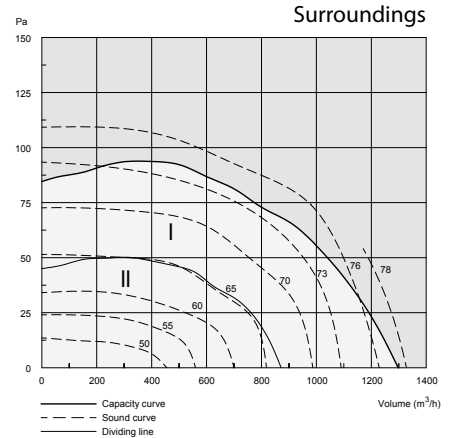
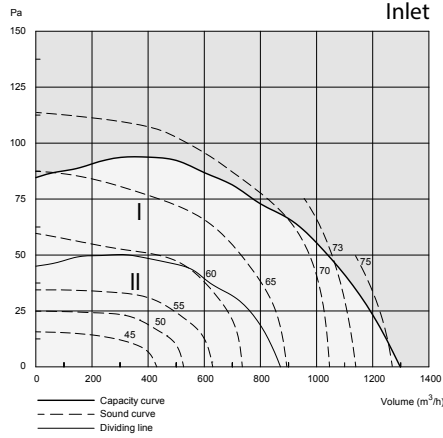

	Area	63 Hz	125 Hz	250 Hz	500 Hz	1000 Hz	2000 Hz	4000 Hz	8000 Hz
Inlet channel ( $K_{W1}$ )	I	14	13	3	-7	-9	-13	-17	-20
	II	17	11	2	-2	-11	-17	-25	-29
Surroundings ( $K_{W3}$ )	I	4	3	-1	-5	-7	-6	-9	-16
	II	11	5	1	-2	-8	-9	-12	-18

	Area	10m							
Pressure ( $K_{PA}$ )	I	-28							
	II	-28							

Sound power output to inlet channel in the first octave band ( $L_{W1}$ )	Area	63 Hz	125 Hz	250 Hz	500 Hz	1000 Hz	2000 Hz	4000 Hz	8000 Hz
	I	83	82	72	62	60	56	52	49
	II	-	-	-	-	-	-	-	-

Sound power output to surroundings in the first octave band ( $L_{W3}$ )	Area	63 Hz	125 Hz	250 Hz	500 Hz	1000 Hz	2000 Hz	4000 Hz	8000 Hz
	I	78	77	73	69	67	68	65	58
	II	-	-	-	-	-	-	-	-

A-weighted sound pressure in ( ) meters distance ( $L_{PA3}$ )	Area	10m	20m	40m	80m				
	I	46	40	34	28				
	II	-	-	-	-				

**Example:** For the values in **Table 3** is read the factor ( $L_{WA1}$ ) in **Diagram A** at 2/3 of max. flow.  
2/3 of 1300 M<sup>3</sup>/h = 867 M<sup>3</sup>/h  
Reading = 69

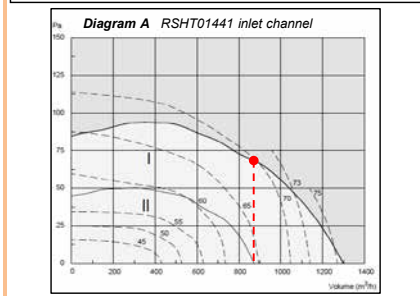

**Example:** For the values in **Table 4** and **Table 5** is read the factor ( $L_{WA3}$ ) in **Diagram B** at 2/3 of max. flow.  
2/3 of 1300 M<sup>3</sup>/h = 867 M<sup>3</sup>/h  
Reading = 74

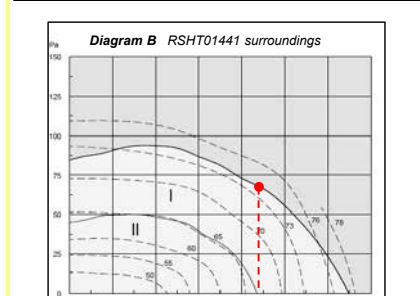

$K_{W1}$ : Correction factor for calculating sound output in the first octave band.  
 $K_{PA}$ : Correction factor for calculating A-weighted sound pressure.

$L_{W1}$ : Sound output level for inlet channel  
 $L_{W3}$ : Sound output level to surroundings  
 $L_{PA3}$ : Sound pressure level dB(A) at a distance of 10 metres from hemi-spherical sound dissipation in free field and with insulated connection ducts..

I: Upper operating area.  
II: Lower operating area.  
 $L_{WA1}$  can be read from the curve diagram.  
 $L_{WA3}$  can be read from the curve diagram.

## Sound data RSHT 016

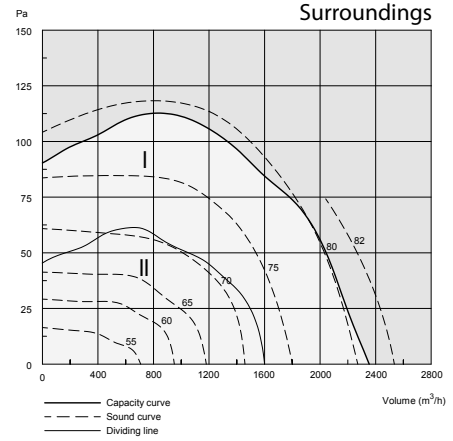
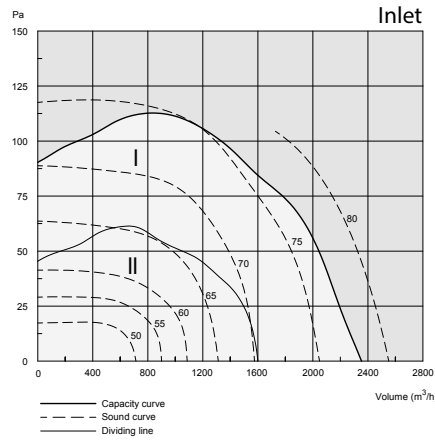

**Table 1**  
Correction factors for calculating sound output in the first octave band to extractor channel and surroundings. [dB]

	Area	63Hz	125 Hz	250 Hz	500 Hz	1000 Hz	2000 Hz	4000 Hz	8000 Hz
Inlet channel ( $K_W$ )	I	15	12	3	-7	-9	-14	-15	-18
	II	18	11	3	-6	-9	-18	-23	-29
Surroundings ( $K_W$ )	I	5	4	1	-5	-6	-7	-10	-15
	II	9	4	4	-4	-8	-11	-15	-21

**Table 2**  
Correction factors for calculating A-weighted sound pressure to surroundings [dB(A)]

	Area	10m							
Pressure ( $K_{pA}$ )	I	-28							
	II	-28							

**Table 3**  
**Example:** Sound power output level for inlet channel [dB] = (Readings in Diagram A) + (Correction factor in Table 1)

Sound power output to inlet channel in the first octave band ( $L_{W1}$ )	Area	63Hz	125 Hz	250 Hz	500 Hz	1000 Hz	2000 Hz	4000 Hz	8000 Hz
I	91	88	79	69	67	62	61	58	
II	-	-	-	-	-	-	-	-	

**Table 4**  
**Example:** Sound power output level for surroundings [dB] = (Readings in Diagram B) + (Correction factor in Table 1)

Sound power output to surroundings in the first octave band ( $L_{W2}$ )	Area	63Hz	125 Hz	250 Hz	500 Hz	1000 Hz	2000 Hz	4000 Hz	8000 Hz
I	83	82	79	73	72	71	68	63	
II	-	-	-	-	-	-	-	-	

**Table 5**  
**Example:** Sound pressure to surroundings [dB(A)] = (Readings in Diagram B) + (Correction factor in Table 2)  
Every time that distance doubles another 6 dB is withdrawn. Example: 20m = 78 - 28 - 6=44

A-weighted sound pressure in ( ) meters distance ( $L_{pA3}$ )	Area	10m	20m	40m	80m				
I	50	44	38	32					
II	-	-	-	-					

**Example:** For the values in Table 3 is read the factor ( $L_{WA1}$ ) in Diagram A at 2/3 of max. flow.  
2/3 of 2375 M<sup>3</sup>/h = 1583 M<sup>3</sup>/h  
Reading = 76

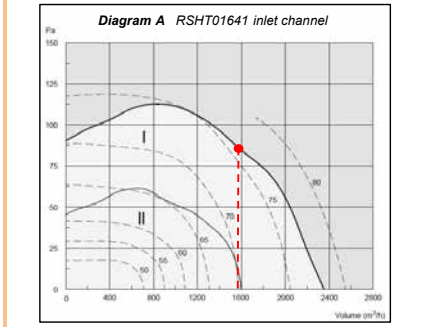

**Example:** For the values in Table 4 and Table 5 is read the factor ( $L_{WA3}$ ) in Diagram B at 2/3 of max. flow.  
2/3 of 2375 M<sup>3</sup>/h = 1583 M<sup>3</sup>/h  
Reading = 78

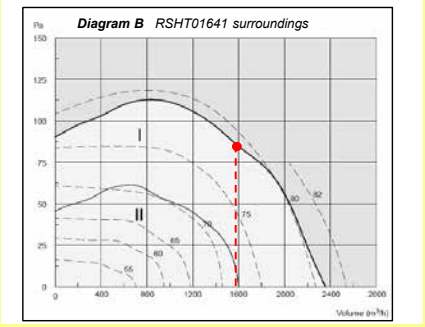

$K_W$ : Correction factor for calculating sound output in the first octave band.  
 $K_{pA}$ : Correction factor for calculating A-weighted sound pressure.

$L_{W1}$ : Sound output level for inlet channel  
 $L_{W2}$ : Sound output level to surroundings  
 $L_{pA3}$ : Sound pressure level dB(A) at a distance of 10 metres from hemi-spherical sound dissipation in free field and with insulated connection ducts.

I: Upper operating area.  
II: Lower operating area.  
 $L_{WA1}$  can be read from the curve diagram.  
 $L_{WA3}$  can be read from the curve diagram.